

**Bendix/King
Silver Crown Plus™
Avionics Systems
Pilot's Guide**

Nav/Comm Systems



Honeywell

The information contained in this manual is for reference use only. If any information contained herein conflicts with similar information contained in the Airplane Flight Manual Supplement, the information in the Airplane Flight Manual Supplement shall take precedence.

WARNING

Prior to export of this document, review for export license requirement is needed.

COPYRIGHT NOTICE

©1998 - 2002 Honeywell International Inc.
All rights reserved.

Reproduction of this publication or any portion thereof by any means without the express written permission of Honeywell International Inc. is prohibited. For further information contact the Manager, Technical Publications; Honeywell Business & General Aviation; One Technology Center; 23500 West 105th Street; Olathe, Kansas 66061. Telephone: (913) 782-0400.

ATTENTION

The operation of the GPS Navigation, Multi-Function Display and/or Traffic Information Services components of your particular Silver Crown Plus System are covered in separate publications. Choose the publication pertaining to your installation from the list below:

<u>Description</u>	<u>Publication Part Number</u>
KMD 150 Multi-Function Display/GPS	006-18220-0000
KLN 94 GPS Navigation System	006-18207-0000
KLN 89B GPS Navigation System	006-08786-0000
KLN 90B GPS Navigation System	006-08772-0000
KMD 550/850 Traffic Addendum	006-18238-0000

KX 155A and KX 165A VHF Communication/Navigation Transceivers

KX 155A and KX 165A Operation (25 kHz Versions)

All controls required to operate the KX 155A and KX 165A are located on the unit front panel.

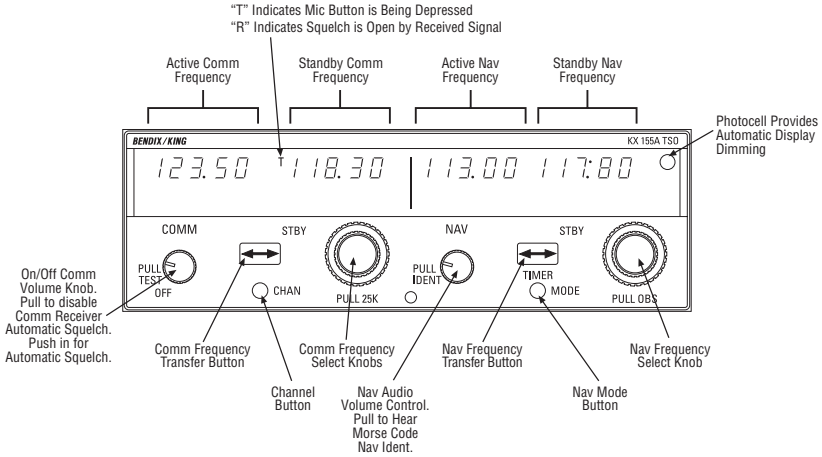

FIGURE 1A
KX 155A and KX 165A (25 kHz Versions) CONTROL FUNCTION

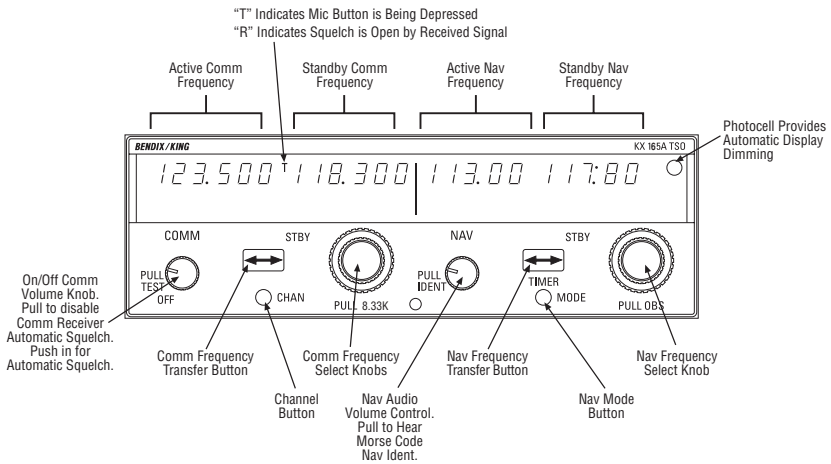

FIGURE 1B
KX 165A (8.33 kHz Versions) CONTROL FUNCTION

NOTE: The 25 kHz and 8.33 kHz versions of the KX 165A are distinguishable from one another in two ways. The 25 kHz version has "PULL 25K" nomenclature below the Comm Frequency Select Knobs while the 8.33 version has "PULL 8.33K". In addition, the 25 kHz version has two digits to the right of the decimal in the Comm frequency while the 8.33 kHz version has three digits to the right of the decimal. The 8.33 kHz channel spacing is required for flight in certain European (ICAO EUR Region) airspace.

COMM Transceiver

Rotate the VOL knob clockwise from the OFF position. Pull the VOL knob out and adjust for desired listening level. Push the VOL knob back in to actuate the automatic squelch.

The left portion of the digital display readout is allocated for COMM ACTIVE and COMM STANDBY frequencies with a "T" between them to indicate TRANSMIT and an "R" to indicate RECEIVE modes of operation.

Select the desired operating frequency in the standby display by rotating the Frequency Select Knobs either clockwise or counterclockwise. A clockwise rotation will increment the previous frequency while a counterclockwise rotation will decrement the previous frequency.

The outer knob will change the MHz portion of the standby display. At one band-edge (118 or 136 MHz) the following 1 MHz change will wrap around to the other band-edge.

KX 155A and KX 165A 25 kHz Versions

The inner knob will change the kHz portion of the standby display. It will change in increments of 50 kHz when the knob is pushed in and 25 kHz when the knob is pulled out. The frequency wrap around at the edge of the band is also utilized when incrementing or decrementing the kHz portion of the standby display.

KX 165A 8.33 kHz Version

The inner knob will change the kHz portion of the standby display. It allows selection of 25 kHz frequencies only when the knob is pushed in and both 8.33 kHz and 25 kHz frequencies when the knob is pulled out. The frequency wrap around at the edge of the band is also utilized when incrementing or decrementing the kHz portion of the standby display.

To tune the radio to the desired operating frequency, the desired frequency must be entered into the standby display (Figure 2) and then the transfer button must be pushed. This will trade the contents of the active and standby displays (Figure 3).

NOTE: An optional remote mounted transfer switch may also be installed in a convenient location (such as the control yoke) to perform the transfer operation.

The operating frequency can also be entered by accessing the ACTIVE ENTRY (direct tune) mode which is done by pushing and holding the COMM TRANSFER button for 2 or more seconds. In the direct tune mode, only the active part of the display is visible (Figure 4). The desired frequency can be directly entered into the display. Push the COMM TRANSFER button again to return to the active/standby display.

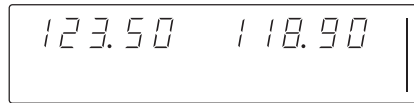

FIGURE 2
Frequency entered in
standby display

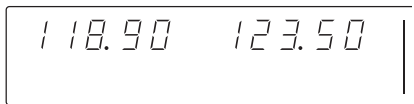

FIGURE 3
Active/standby frequencies toggle



FIGURE 4
Frequency entered in active entry mode

The transceiver is always tuned to the frequency appearing in the ACTIVE display. It is therefore possible to have two different frequencies stored in the ACTIVE and STANDBY displays and to change back and forth between them at the simple push of the transfer button.

During the transmit mode of operation, a "T" will appear between the ACTIVE and STANDBY displays. An "R" will appear between the ACTIVE and STANDBY displays if a detected signal is strong enough to open the squelch, signifying that the transceiver is in the receive mode of operation.

A non-volatile memory stores the comm ACTIVE and STANDBY frequencies on power down. When the unit is turned on again, the COMM ACTIVE and STANDBY windows will display the same ACTIVE and STANDBY frequencies that were displayed before power down.

The KX 155A and KX 165A also have provisions to program 32 channels. Pressing the CHAN button for 2 or more seconds will cause the unit to enter the channel program mode. Upon entering the channel program mode, "PG" is displayed next to the channel number and the channel number will flash indicating that it can be programmed (Figure 5).

The desired channel can be selected by turning the comm kHz knob (Figure 6). The channel frequency can be entered by pushing the COMM TRANSFER button which will cause the standby frequency to flash. The comm frequency knobs are then used to enter the desired frequency (Figure 7). If dashes (displayed when rotating the outer knob between 136 MHz and 118 MHz) are entered instead of a frequency, the corresponding channel is skipped in channel selection mode (Figure 8). Additional channels may be programmed by pressing the COMM TRANSFER button and using the same procedure. To exit the program mode and save the channel information, momentarily push the CHAN button. This will cause the unit to return to the previous frequency entry

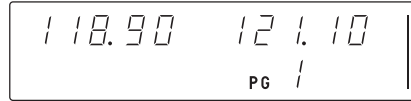

FIGURE 5
Entering channel program mode

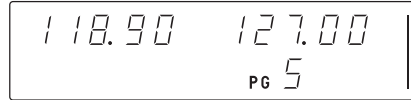

FIGURE 6
Selecting desired channel

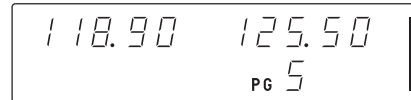

FIGURE 7
Selecting desired frequency

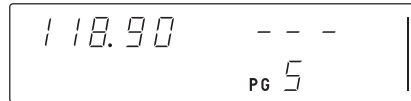

FIGURE 8
Corresponding channel is skipped in channel selection mode

Silver Crown Plus Pilot's Guide

mode. The unit will also exit the channel program mode if there is no button or knob activity for 20 seconds.

The channel selection mode can then be entered by momentarily pushing the CHAN button (Figure 9). "CH" is displayed next to the last used channel number.

NOTE: If no channels have been programmed, channel 1 appears with dashes displayed.

The comm frequency knobs can be used to select the desired channel (Figure 10). The unit will automatically exit the channel mode, with the channel frequency remaining in the STANDBY window, if no channel is selected within 5 seconds after entering the channel selection mode. The channel frequency is then made the ACTIVE frequency in the normal manner by pressing the COMM TRANSFER button.

NOTE: An optional remote mounted channel switch may be installed that increments the next programmed channel into the standby window each time the switch is activated.

The unit is placed in the transmit mode by depressing the MIC KEY button. The unit has a stuck microphone alert feature. If the microphone is keyed continuously for greater than 33 seconds, the transmitter stops transmitting and the active Comm frequency flashes to alert the pilot of the stuck microphone condition.

NOTE: Radio control of airport runway lighting is available at selected airports to provide airborne control of lights by keying the aircraft's microphone. Approved lighting systems may be activated by keying the microphone as indicated below:

7 times in 5 sec. - Highest intensity available
5 times in 5 sec. - Medium or lower intensity
3 times in 5 sec. - Lowest intensity available

Do to the close proximity of airports using the same frequency, an airport's radio controlled lighting receiver may be set at a low sensitivity, requiring the aircraft to be relatively close to activate the system. It is also important to be very deliberate with the keying. The require-

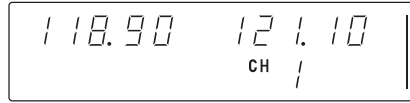

FIGURE 9
Entering channel selection mode

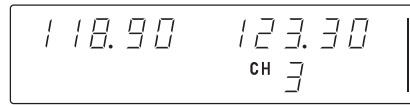

FIGURE 10
Selecting desired channel

ment for the ground station decoder is such that it will not respond to very rapid or “staccato” transmissions. If the first attempt at lighting the runway lights is unsuccessful, repeat with a slower, more deliberate cadence of microphone keying.

NAV Receiver

The right portion of the display is allocated to NAV receiver information. The frequency channeling is similar to the COMM when operating in the frequency mode (Figure 1A and 1B). The NAV increment/decrement knobs are located on the right hand side of the front panel. The outer knob operates in 1 MHz steps and increments/decrements the STANDBY frequency display.

The inner knob operates in 50 kHz steps. The NAV receiver’s lower and upper frequency limits are 108.00 MHz and 117.95 MHz. Exceeding the upper limit of frequency band will automatically return to the lower limit and vice versa.

Depressing the NAV frequency transfer button for 2 seconds or more will cause the display to go in to the ACTIVE ENTRY mode. Only the ACTIVE frequency will be displayed and it can be directly changed by using the NAV inc/dec knobs. The display will return to the ACTIVE/STANDBY mode when the NAV frequency transfer button is pushed.

Depressing the mode button will cause the NAV display to go from the ACTIVE/STANDBY format to the ACTIVE/CDI (Course Deviation Indicator) format as shown in Figure 11. The vertical “needle” moves side to side similar to a mechanical CDI. When the needle is centered, the aircraft is on the selected OBS course. When the active frequency is tuned to a VOR frequency, the center of the CDI scale displays the “TO” or “FROM” indicator.

In the CDI mode, the increment/decrement knob (pushed in) channels the ACTIVE frequency window and depressing the frequency transfer button will

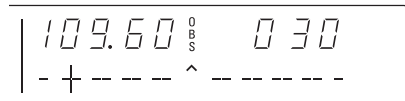

FIGURE 11
Nav display active VOR frequency/
CDI format

Silver Crown Plus Pilot's Guide

cause the ACTIVE frequency to be placed in blind storage and the STANDBY frequency (in blind storage) to be displayed in the ACTIVE window display.

When the ACTIVE window is tuned to a VOR frequency, the standby frequency area is replaced by a three digit OBS (Omni Bearing Selector) display. The desired OBS course can be selected by pulling out the inner NAV frequency knob and turning it. The CDI needle may be automatically centered with a "TO" indication by depressing the mode button for 2 seconds. This OBS display is independent of any OBS course selected on an external CDI or HSI. An "OBS" in the middle of the NAV display will flash while the inner NAV frequency knob is pulled out. The CDI is displayed on the line below the frequency/OBS.

When the ACTIVE window is tuned to a localizer frequency, the standby frequency area is replaced by "LOC" (Figure 12).

When the received signal is too weak to ensure accuracy the display will "flag". See Figure 13.

Depressing the mode button will cause the NAV display to go from the ACTIVE/CDI format to the ACTIVE/BEARING format. In the BEARING mode, the increment/decrement knob channels the ACTIVE frequency window and depressing the frequency transfer button will cause the ACTIVE frequency to be placed in blind storage and the STANDBY frequency (in blind storage) to be displayed in the ACTIVE window display. In bearing mode of operation, the right hand window of NAV display shows the bearing TO the station.

Figure 14 illustrates the NAV side of the display in this mode.

When a too weak or invalid VOR signal is received the display flags as shown in Figure 15.

Another push of the mode button will cause the NAV display to go from the ACTIVE/BEARING format to the ACTIVE/RADIAL format as shown in Figure 16. In the RADIAL mode, the

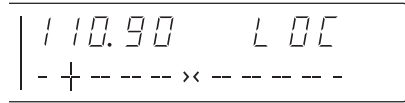

FIGURE 12
Nav display Active localizer frequency/
CDI format

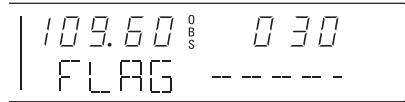

FIGURE 13
VOR flag display



FIGURE 14
VOR mode bearing to function

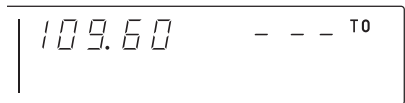

FIGURE 15
VOR mode active/bearing,
flag display

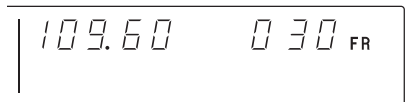

FIGURE 16
VOR mode
radial from function

increment/decrement knob channels the ACTIVE frequency window and depressing the frequency transfer button will cause the ACTIVE frequency to be placed in blind storage and the STANDBY frequency (in blind storage) to be displayed in the ACTIVE window display. In radial mode of operation, the right hand window of NAV display shows the radial FROM the station. Figure 16 illustrates the NAV side of the display in this mode:

When a too weak or invalid VOR signal is received the display flags as shown in Figure 17.

Another push of the mode button will cause the unit to go into the TIMER mode. See Figure 18. When the unit is turned on the elapsed timer begins counting upwards from zero. The timer can be stopped and reset to zero by pushing the NAV frequency transfer button for 2 seconds or more causing the ET on the display to flash. In this state the timer can be set as a countdown timer or the elapsed timer can be restarted. The countdown timer is set by using the NAV inc/dec knobs to set the desired time and then pushing the NAV frequency transfer button to start the timer. The outer knob selects minutes, the inner knob in the "in" position selects ten second intervals, and the inner knob in the "out" position selects individual seconds. After the countdown timer reaches zero, the counter will begin to count upwards indefinitely while flashing for the first 15 seconds. Or the elapsed timer can also be reset to zero and started again after it has been stopped and reset to zero by pushing the NAV frequency transfer button. The Audio Alert, if installed, is then sounded.

The NAV ACTIVE and STANDBY frequencies are stored in the memory on power down and return on power up.

When the smaller increment/decrement knob is pushed in, depressing the NAV TRANSFER button will interchange the ACTIVE and STANDBY frequencies. The NAV IDENT knob is active in the



FIGURE 17
VOR mode
active/radial flag display



FIGURE 18
Timer mode

pulled out position so that both voice and ident can be heard. When this knob is pushed in, the ident tone is attenuated. The volume of voice/ident can be adjusted by turning this knob.

Pilot Configuration

This mode can be accessed by pressing and holding the Nav Mode Button for more than 2 seconds and then pressing the Nav Frequency Transfer Button for an additional 2 seconds, while continuing to hold the Nav Mode Button. When the Pilot Config Mode is entered the unit will show the "SWRV" mnemonic which is the unit software revision level. Adjustment pages can be accessed by MODE button presses.

The pilot may adjust two parameters in the pilot configuration, the display minimum brightness and sidetone volume level.

Minimum Brightness (BRIM) will have a range of 0 - 255. The dimmest is 0 and the brightest is 255.

Sidetone volume level is adjusted when SIDE is displayed. Values from 0 - 255 may be selected with 0 being least volume, 255 being the greatest.

Subsequent presses of the MODE button sequences through SWRV, BRIM, SIDE, and then back to SWRV.

Momentarily pressing the Nav Transfer Button exits Pilot configuration mode. The Nav returns to its pre-Pilot Config state with the new brightness and sidetone levels stored in non-volatile memory.

Default Mode

Turning on the KX 155A or KX 165A while pressing either the COMM or NAV frequency transfer button will bring the unit up in the Direct Tune Mode. 120.00MHz (120.000MHz in 8.33 kHz KX 165A) will be the active COMM frequency and 110.00 MHz will be the active NAV frequency. This will aid the pilot in blind tuning the radio in the unlikely event of display failure.

Honeywell International Inc.
One Technology Center
23500 West 105th Street
Olathe, KS 66061
Telephone (913) 782-0400
FAX 913-712-1302

©1998-2002 Honeywell International Inc.
006-18110-0000 Printed in U.S.A.
Revision 4 Nov/2002

Honeywell